

### TECHNICAL SPECIFICATIONS

VOLTS	120	
AMPS	12.5	
WATTS	1500	
HEATER	HIGH	1500 watts
	LOW	750 watts
NO HEATER	19 watts	
LAMPS	QUANTITY	LED
	WATTS	
	TOTAL WATTS	19 watts
ROTOR MOTOR	1 at 5 watts	
HEIGHT,WIDTH,DEPTH	26 5/8" x 53 1/4" x 10 5/8"	
GLASS VIEWING OPENING	15 5/8" X 49 5/8"	
GLASS SIZE	15 5/8" X 49 5/8"	
SHIPPING SIZE	29 1/8" x 57 4/8" x 12 5/8"	
SHIPPING WEIGHT	00.0 lbs	
GLASS FRONT	UNIT	
		Included
PLUG LOCATION	Left Side	
CORD LENGTH	76"	
APPROX. HEATING AREA	400 sq ft	

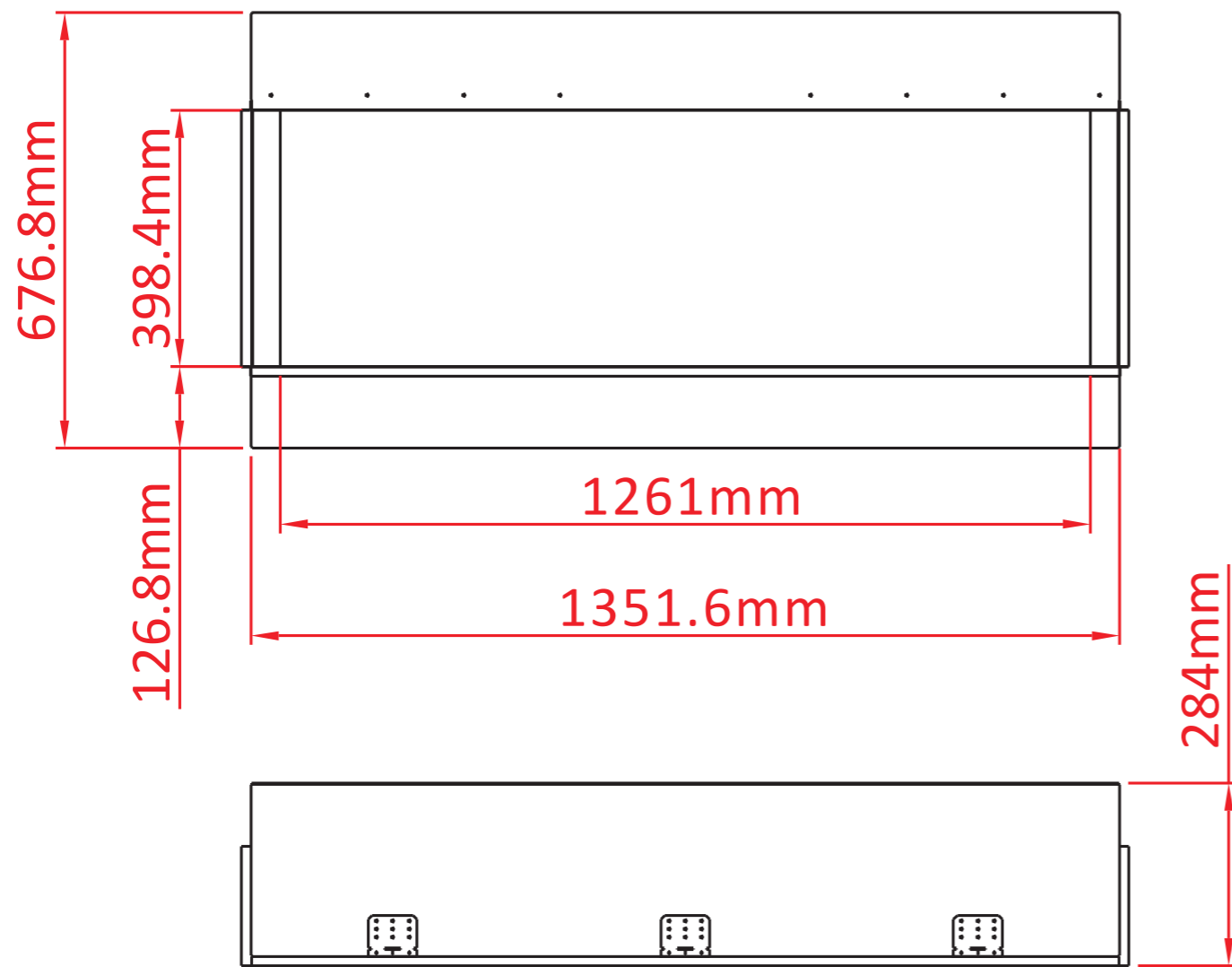

SERIES	MODEL		REV
BAY	50-BAY-SLIM		1
SCALE 1"=1'-0"	DATE: 9/4/2019	SHEET 1 OF 1	



**TECHNICAL SPECIFICATIONS**

VOLTS		120
AMPS		12.5
WATTS		1500
HEATER	HIGH	1500 watts
	LOW	750 watts
NO HEATER		19 watts
LAMPS	QUANTITY	LED
	WATTS	
	TOTAL WATTS	19 watts
ROTOR MOTOR		1 at 5 watts
HEIGHT,WIDTH,DEPTH		67.7 x 135.1 x 26.9 cm
GLASS VIEWING OPENING		39.8 X 126.1 cm
GLASS SIZE		39.8 X 126.1 cm
SHIPPING SIZE		74 x 146.2 x 32 cm
SHIPPING WEIGHT		00.0 Kgs
	UNIT	
	GLASS FRONT	Included
PLUG LOCATION		Left Side
CORD LENGTH		193 cm
APPROX. HEATING AREA		37 sqm



SERIES	MODEL		REV
BAY	50-BAY-SLIM		1
SCALE 1:12	DATE: 9/4/2019	SHEET 1 OF 1	